

# STI MANUFACTURING, INC.

## HEAVY DUTY THREADED THERMOWELLS

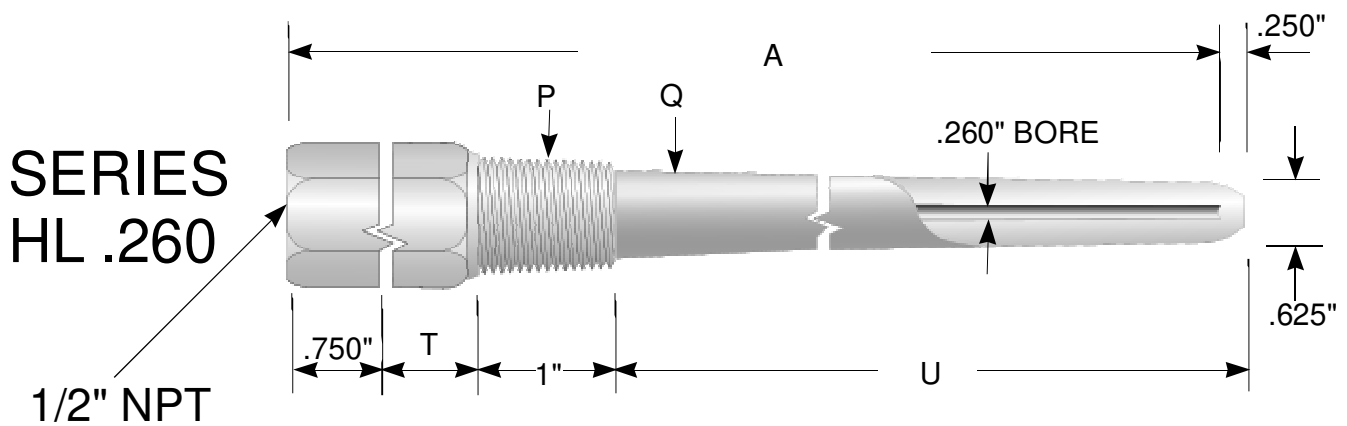
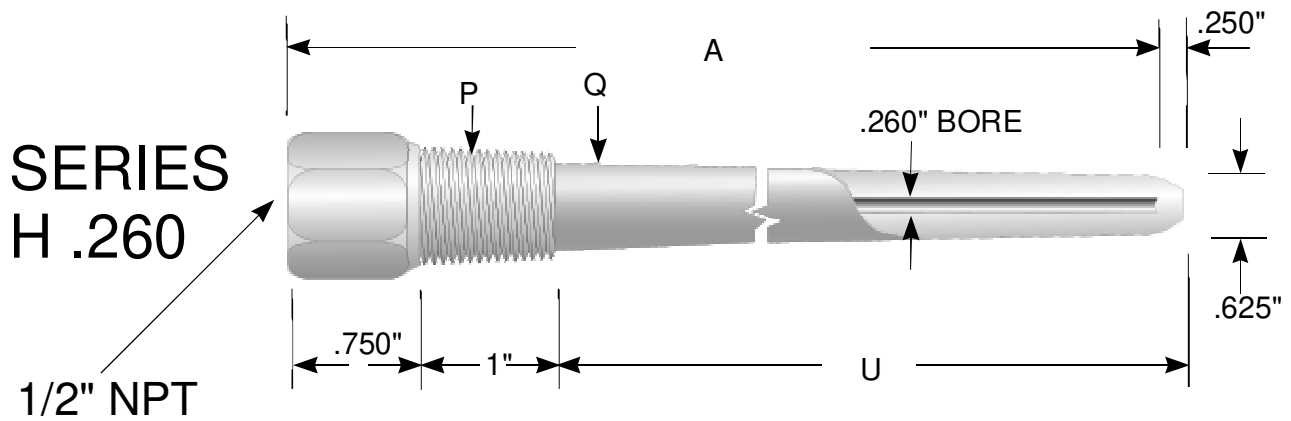

SERIES H .260

EXTERNAL THREAD P	CODE NUMBER	INSERT LENGTH U	STEM LGTH A	SHANK DIA Q
3/4" NPT	3/4"-H .260-U 2 1/2	2-1/2"	4"	7/8"
		4-1/2"	6"	7/8"
		7-1/2"	9"	7/8"
		10-1/2"	12"	7/8"
		13-1/2"	15"	7/8"
		16-1/2"	18"	7/8"
1" NPT	1"-H .260-U 2 1/2	2-1/2"	4"	1-1/16"
		4-1/2"	6"	1-1/16"
		7-1/2"	9"	1-1/16"
		10-1/2"	12"	1-1/16"
		13-1/2"	15"	1-1/16"
		16-1/2"	18"	1-1/16"
		22-1/2"	24"	1-1/16"

SERIES HL .260

EXTERNAL THREAD P	CODE NUMBER	INSERT LENGTH U	STEM LGTH A	LAG EXT. T	SHANK DIA Q
3/4" NPT	3/4"-HL .260-U 2 1/2	2-1/2"	6"	T2	7/8"
		4-1/2"	9"	T3	7/8"
		7-1/2"	12"	T3	7/8"
		10-1/2"	15"	T3	7/8"
		13-1/2"	18"	T3	7/8"
		16-1/2"	24"	T3	7/8"
1" NPT	1"-HL .260-U 2 1/2	2-1/2"	6"	T2	1-1/16"
		4-1/2"	9"	T3	1-1/16"
		7-1/2"	12"	T3	1-1/16"
		10-1/2"	15"	T3	1-1/16"
		13-1/2"	18"	T3	1-1/16"
		16-1/2"	24"	T3	1-1/16"